

8 7 6 5 4 3 2 1

ECO#	REV.	DESCRIPTION	REV. BY:	DATE
6892	AD1	J1 TO 400-242-00	KR	3-17-04
7092	B00	0006960-01 WAS -00	TH	5-18-04
7552	C01	0006960-02 WAS -01	TH	1-19-05
7552	C01	Bus 1-8 output gains chg'd to unity	je	5-16-05

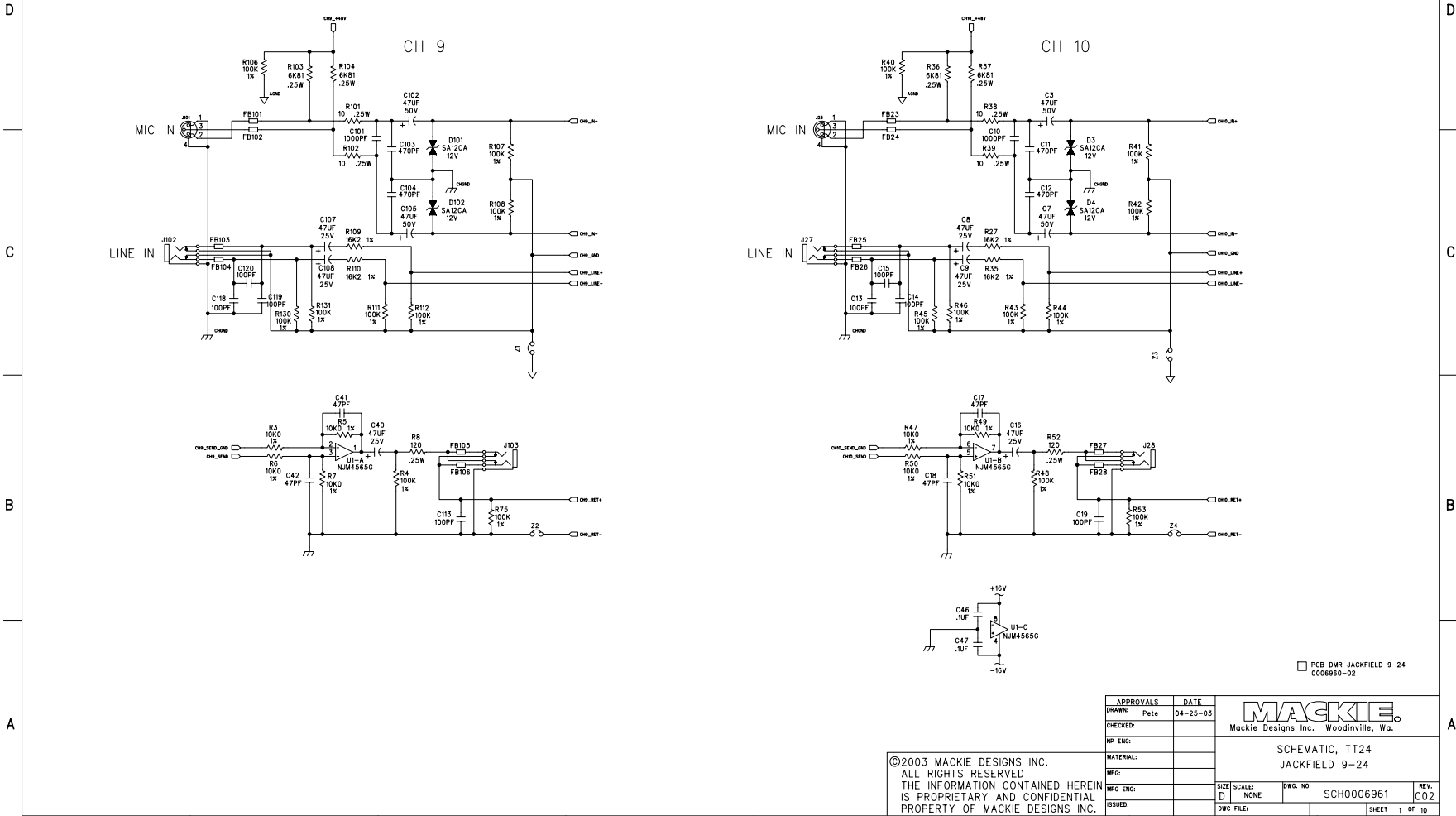

PCB DMR JACKFIELD 9-24
0006960-02

APPROVALS	DATE
DRAWN: Pete	04-25-03
CHECKED:	
MP ENG:	
MATERIAL:	
MFR:	
MFG ENG:	
ISSUED:	



Mackie Designs Inc. Woodinville, Wa.
SCHEMATIC, TT24
JACKFIELD 9-24

© 2003 MACKIE DESIGNS INC.
ALL RIGHTS RESERVED.
THE INFORMATION CONTAINED HEREIN
IS PROPRIETARY AND CONFIDENTIAL
PROPERTY OF MACKIE DESIGNS INC.

SIZE	SCALE:	DWG. NO.	REV.
D	NONE	SCH0006961	C02
ISSUED:	DWG FILE:		SHEET 1 OF 10

8 7 6 5 4 3 2 1

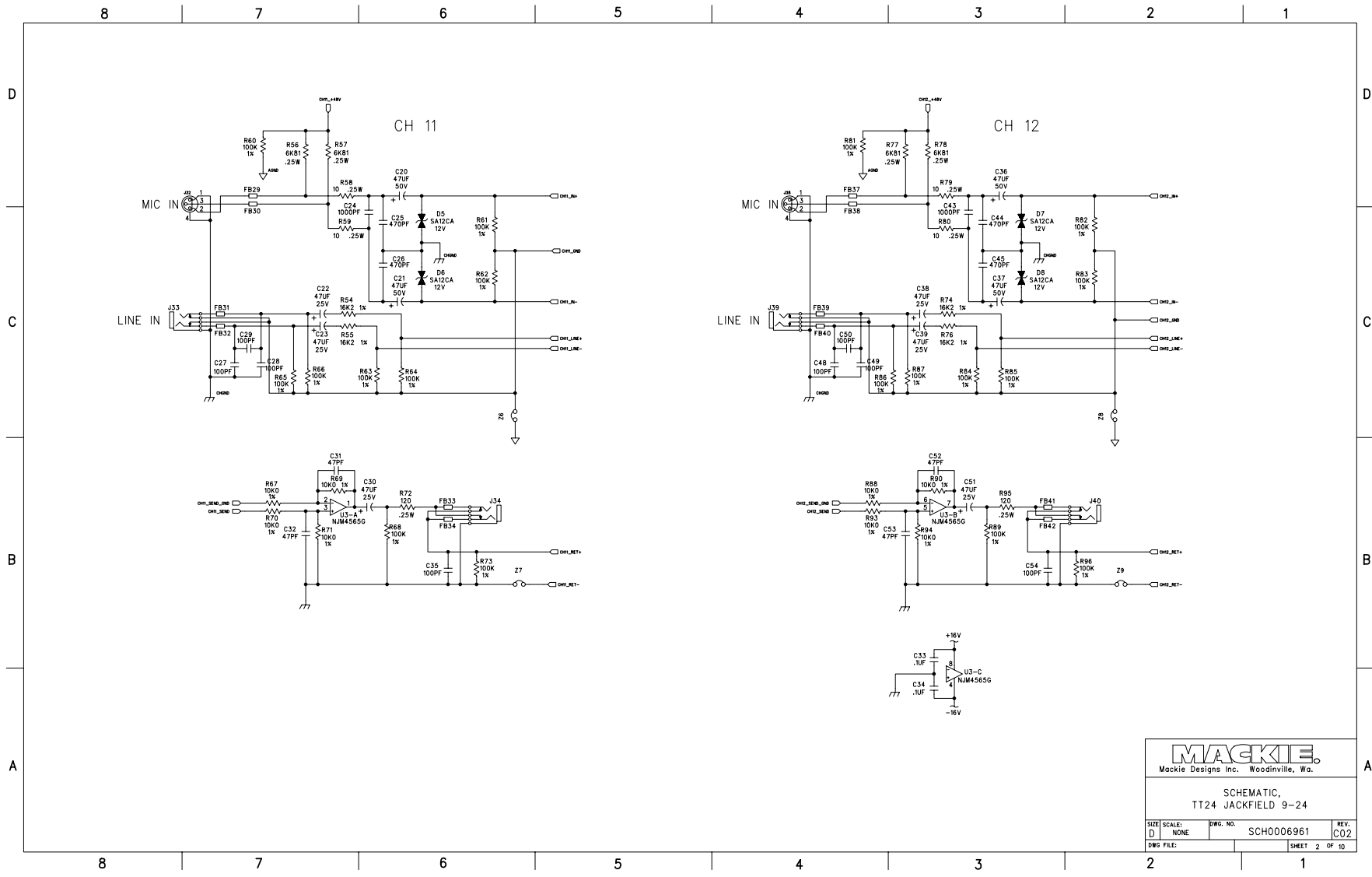

MACKIE
 Mackie Designs Inc. Woodinville, Wa.

SCHEMATIC,
 TT24 JACKFIELD 9-24

SIZE: D	SCALE: NONE	DWG. NO. SCH0006961	REV. C02
DWG. FILE:		SHEET 2 OF 10	

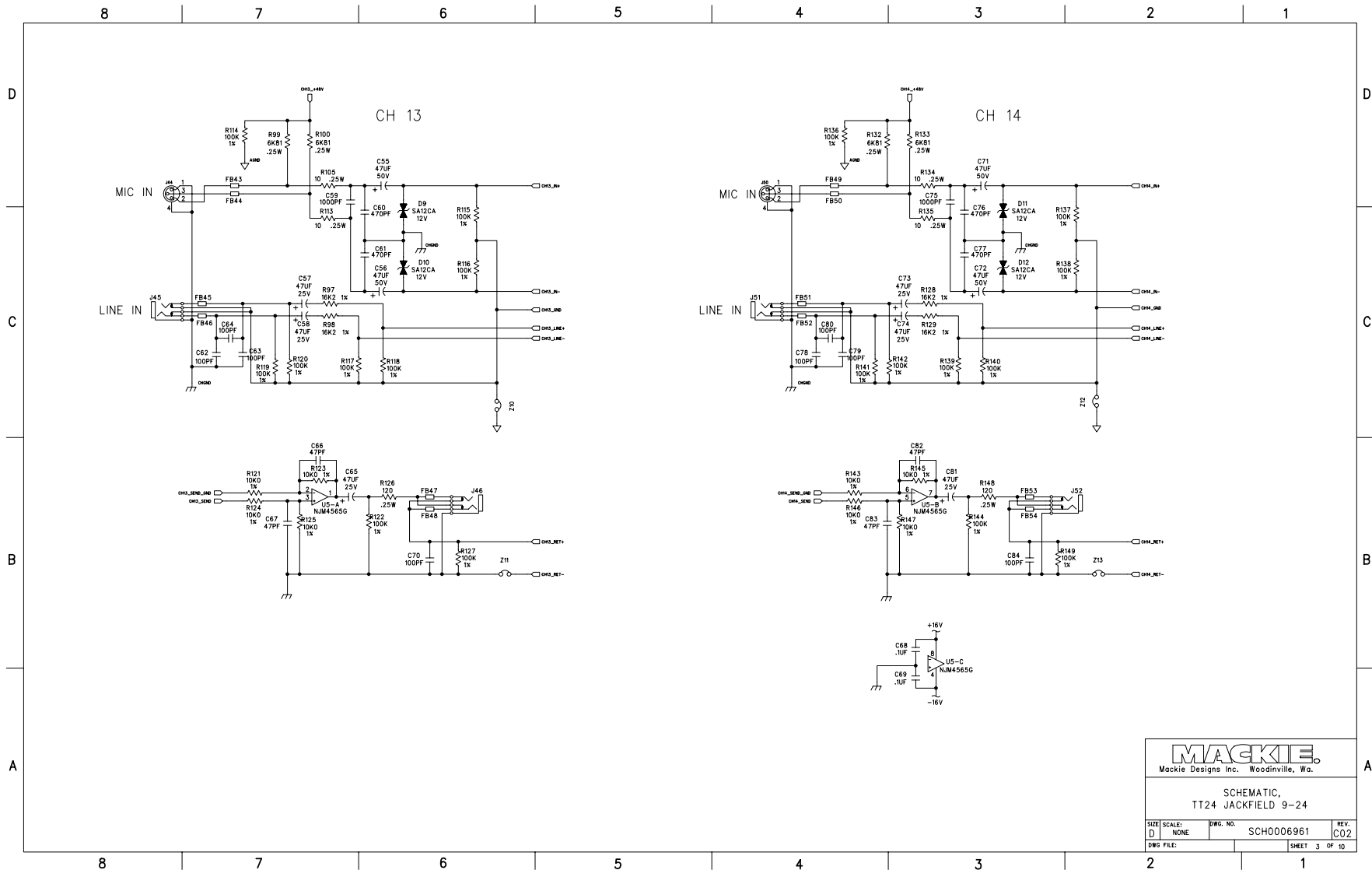

MACKIE
 Mackie Designs Inc. Woodinville, Wa.

SCHEMATIC,
 TT24 JACKFIELD 9-24

SIZE: D	SCALE: NONE	DWG. NO. SCH0006961	REV. C02
DWG. FILE:			SHEET 3 OF 10

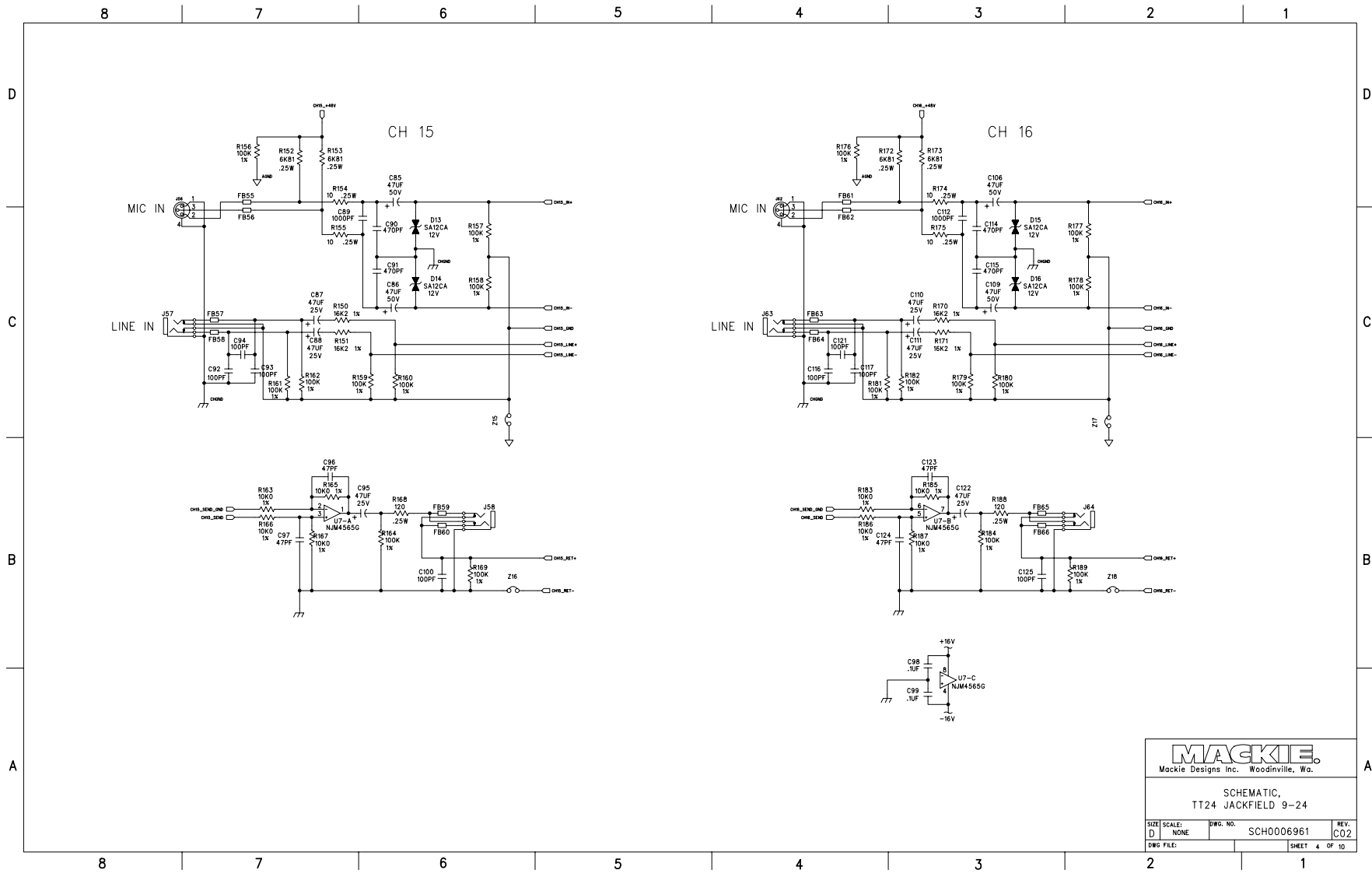

MACKIE
 Mackie Designs Inc. Woodinville, Wa.

SCHEMATIC,
 TT24 JACKFIELD 9-24

SIZE: D	SCALE: NONE	DWG. NO. SCH0006961	REV. C02
DWG. FILE:			SHEET 4 OF 10

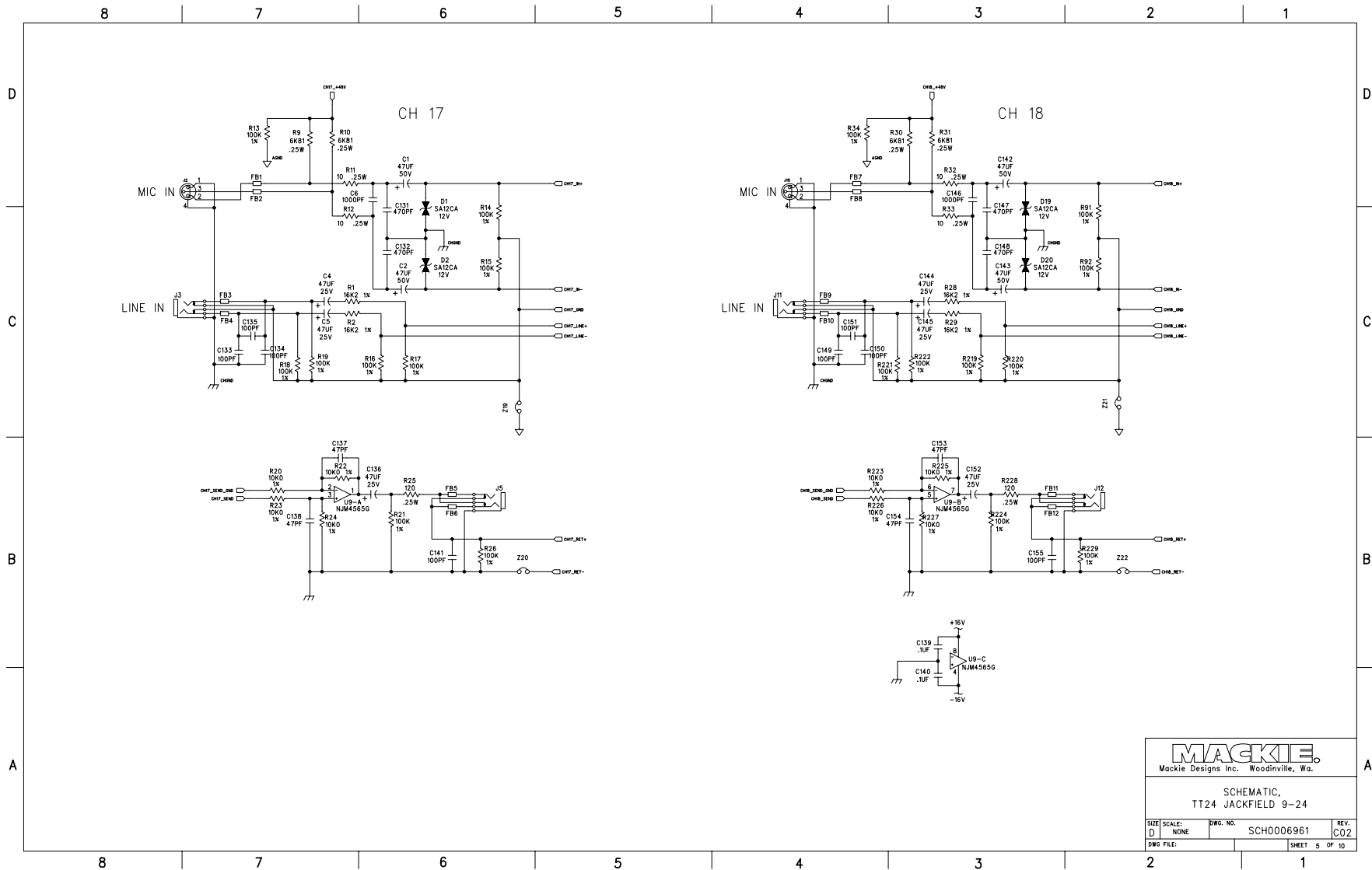

MACKIE
 Mackie Designs Inc. Woodinville, Wa.

SCHEMATIC,
 TT24 JACKFIELD 9-24

SIZE: D	SCALE: NONE	DWG. NO. SCH0006961	REV. C02
DWG. FILE:			SHEET 5 OF 10

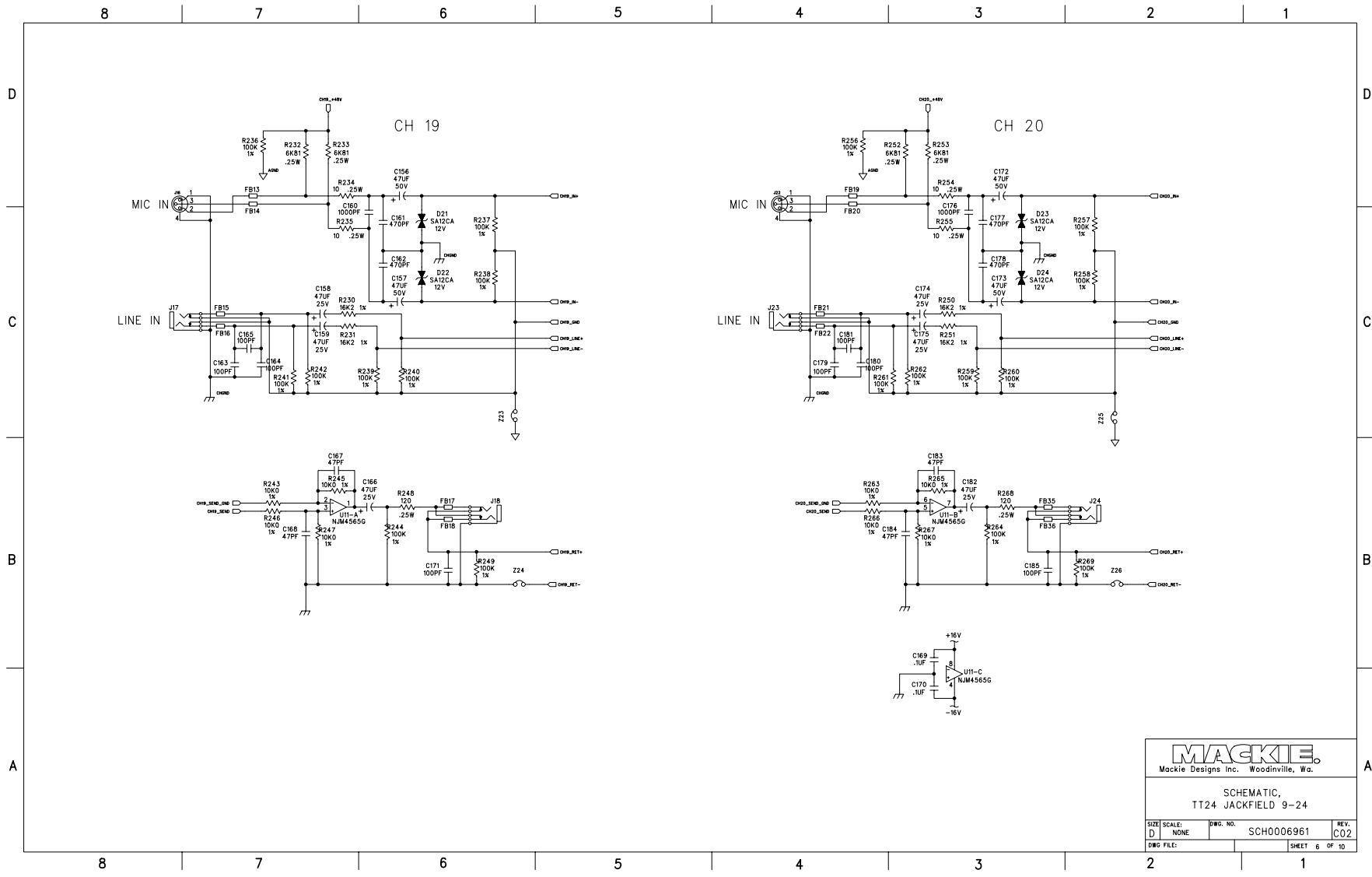

MACKIE
 Mackie Designs Inc. Woodinville, Wa.

SCHEMATIC,
 TT24 JACKFIELD 9-24

SIZE: D	SCALE: NONE	DWG. NO.: SCH0006961	REV. C02
DWG. FILE:			SHEET 6 OF 10

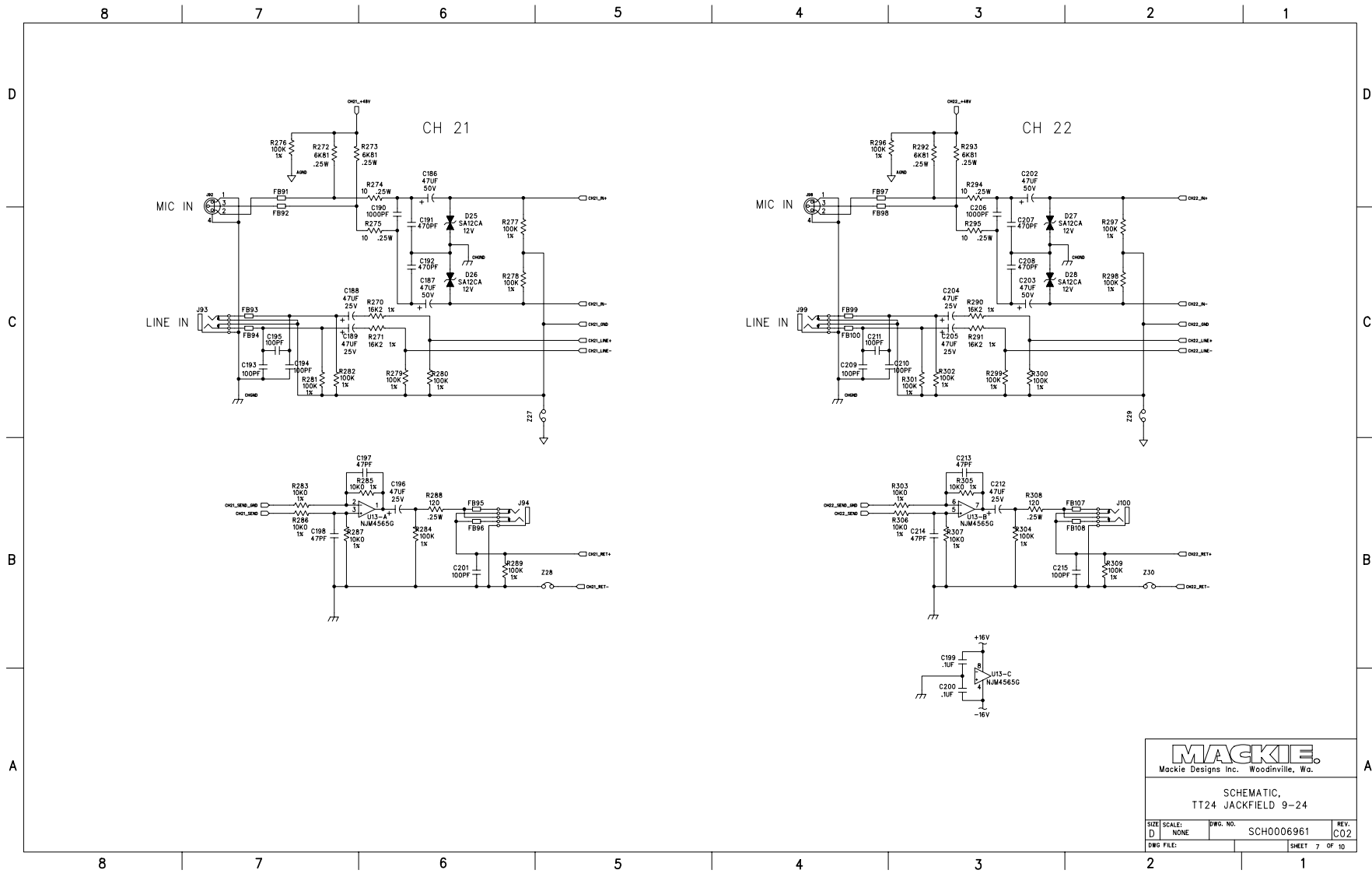

MACKIE
 Mackie Designs Inc. Woodinville, Wa.

SCHMATIC,
 TT24 JACKFIELD 9-24

SIZE: D	SCALE: NONE	DWG. NO: SCH0006961	REV: C02
DWG. FILE:			SHEET 7 OF 10

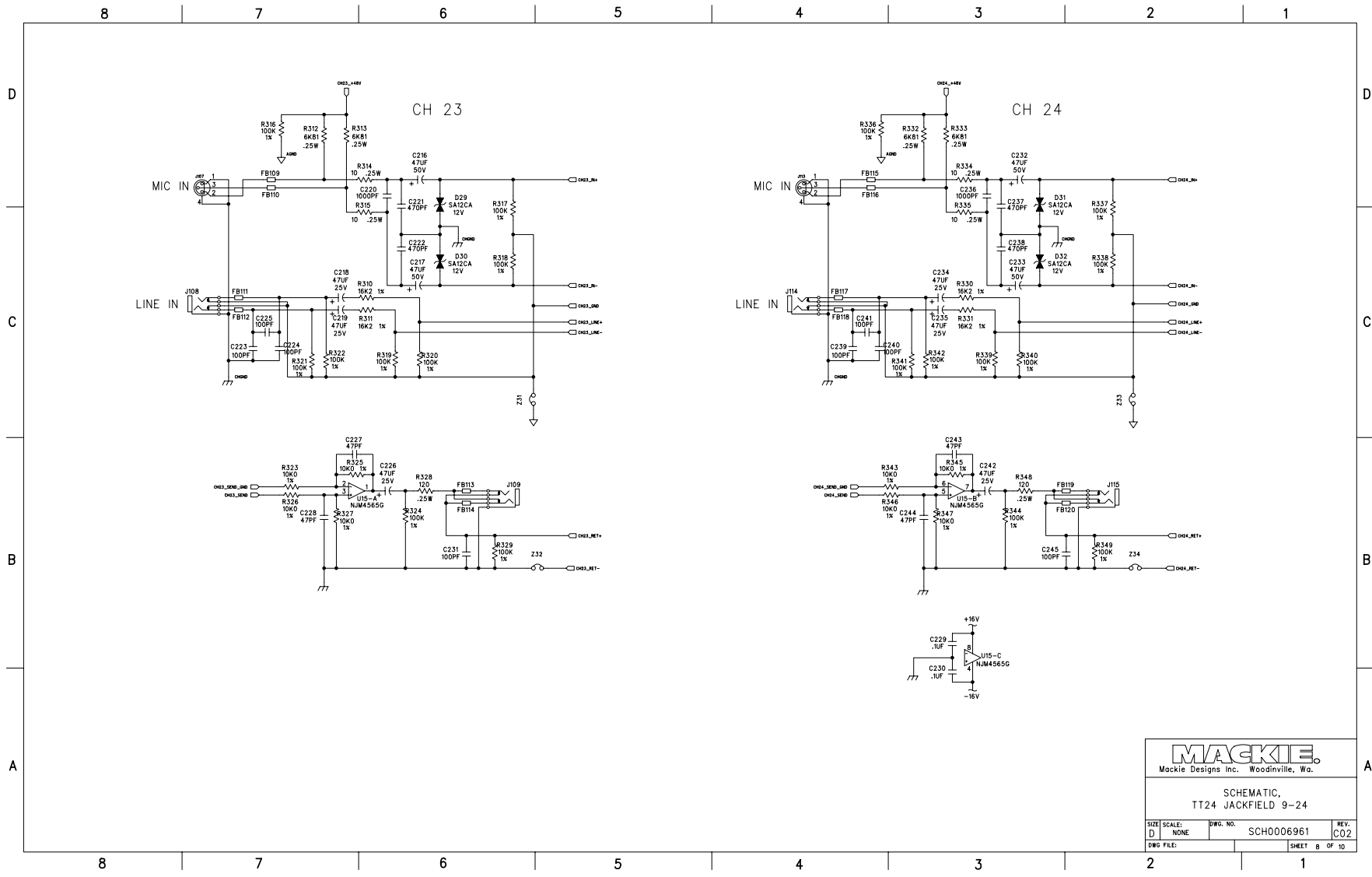

MACKIE
 Mackie Designs Inc. Woodinville, Wa.

SCHEMATIC,
 TT24 JACKFIELD 9-24

SIZE: D	SCALE: NONE	DWG. NO: SCH0006961	REV: C02
DWG FILE:			SHEET 8 OF 10

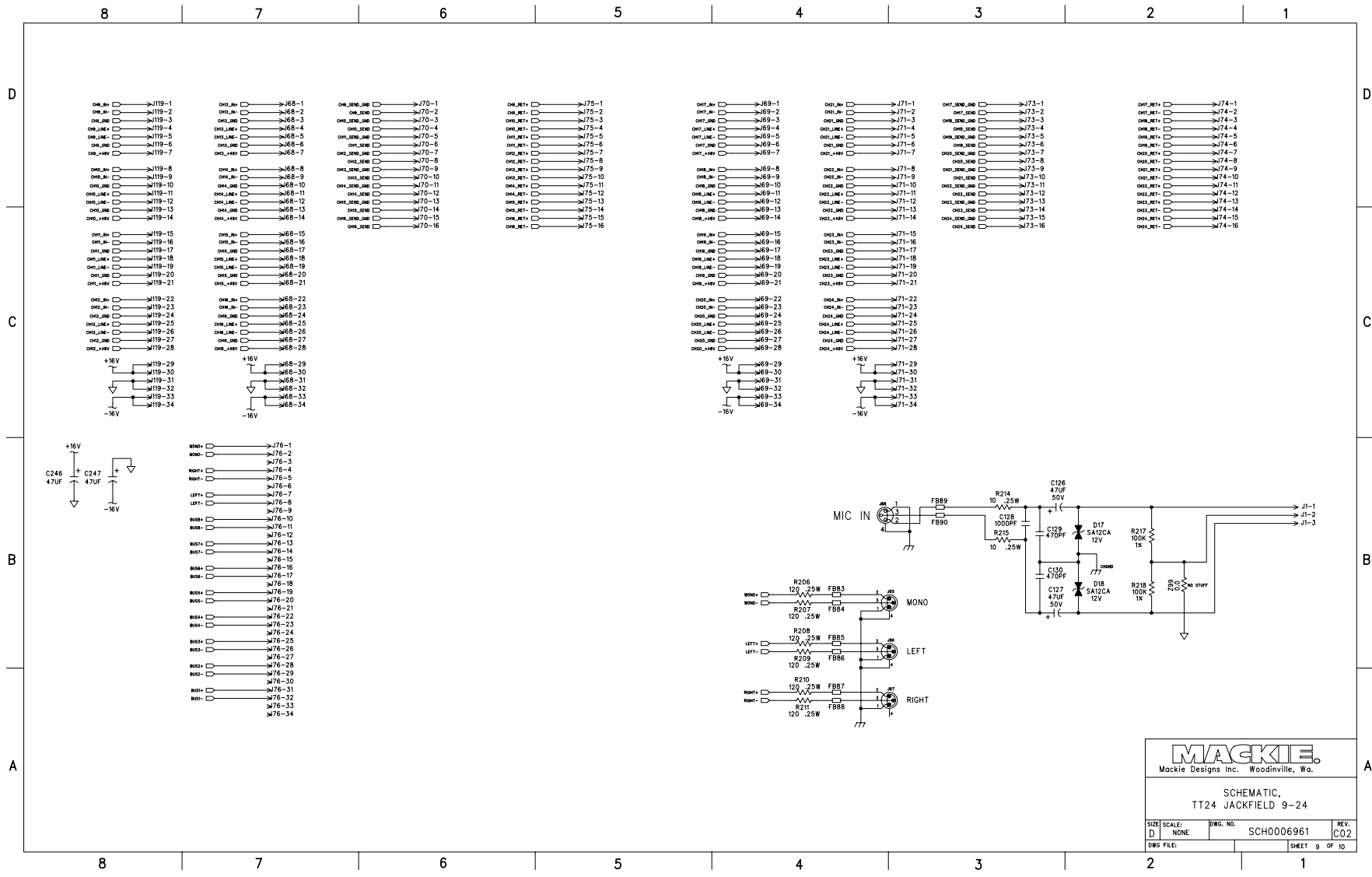

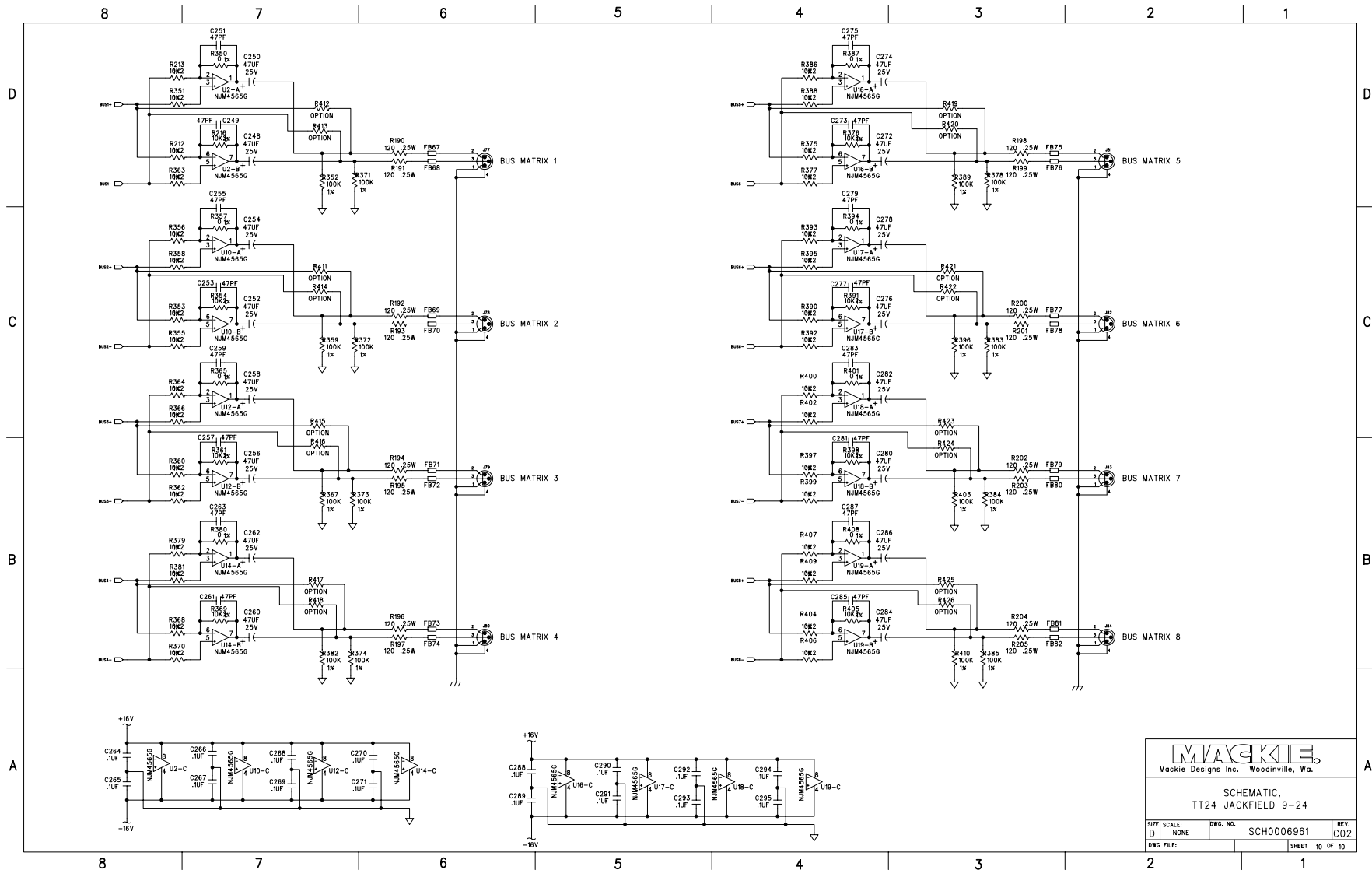

MACKIE
 Mackie Designs Inc. Woodinville, Wa.

SCHEMATIC,
 TT24 JACKFIELD 9-24

SIZE SCALE: D NONE	DWG. NO. SCH0006961	REV. C02
DWG. FILE:		SHEET 10 OF 10