

ECO#	REV.	DESCRIPTION	REV. BY:	DATE
6743	A00	RELEASE TO PRODUCTION	KR	2-9-04

Expansion Slot #1

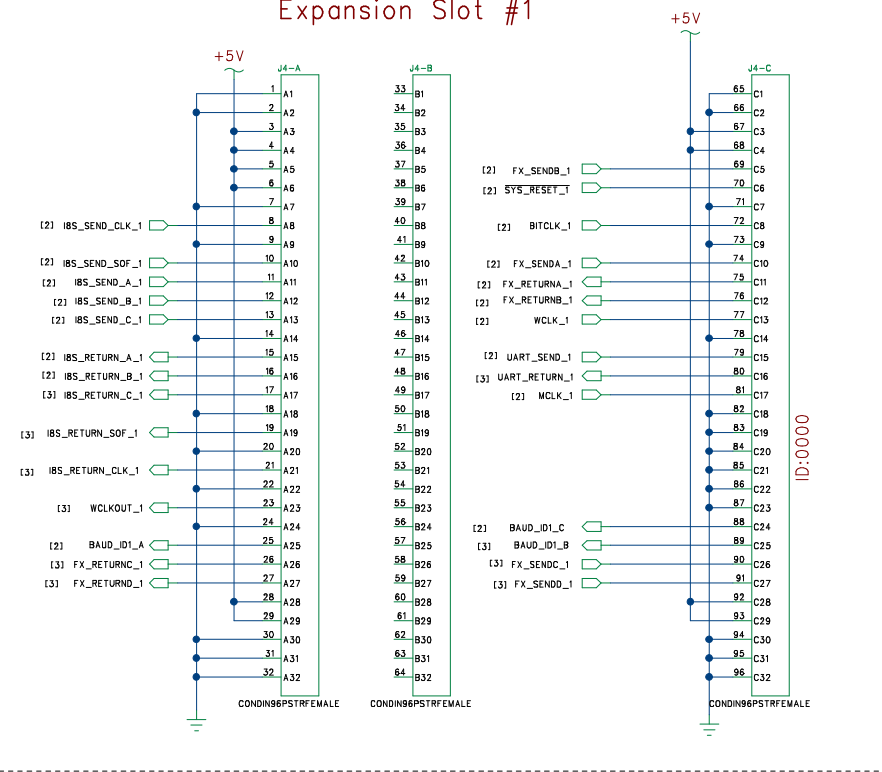

Expansion Slot #2

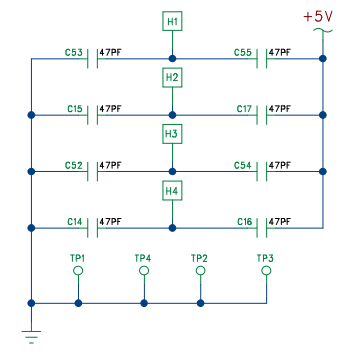
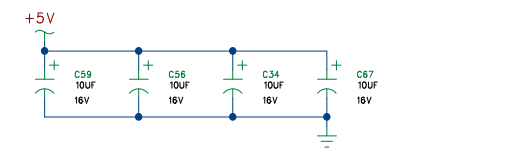
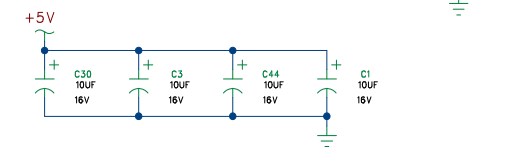
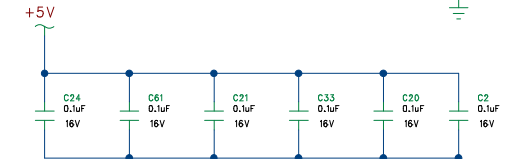
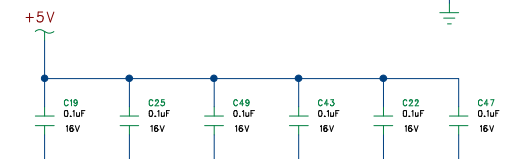
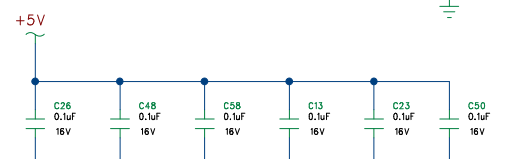
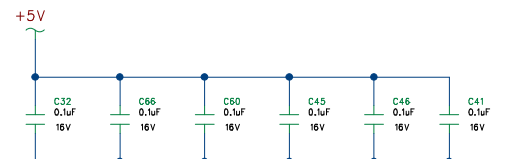
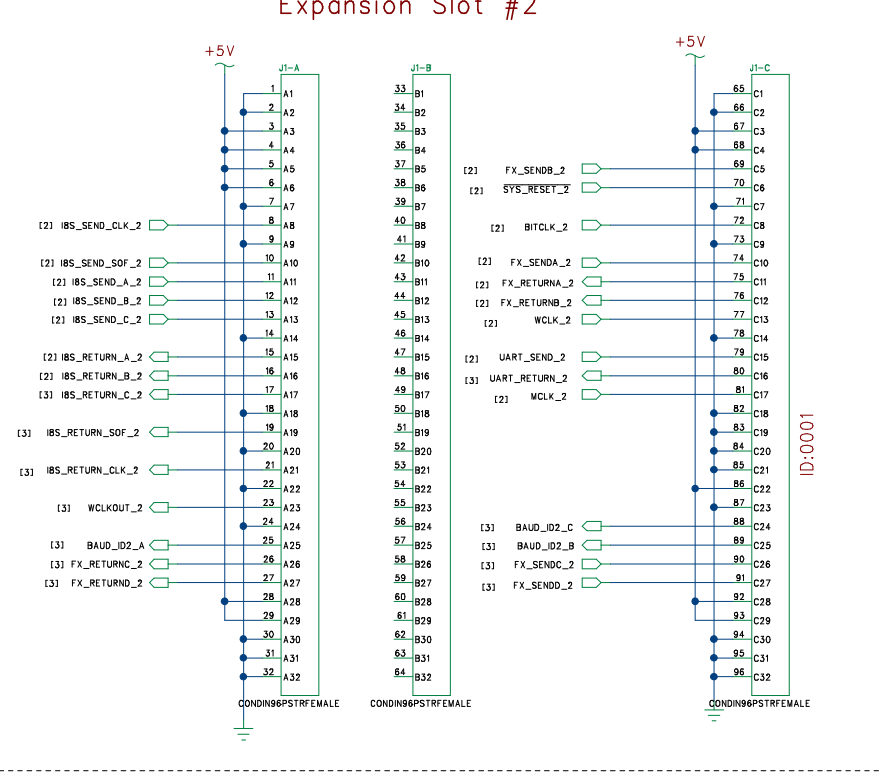

Z100 0006913-00 PCB, BACKPLANE

APPROVALS		DATE	MACKIE			
DRAWN:	F. Warne	2004.01.29	Mackie Designs Inc. Woodinville, Wa.			
CHECKED:			TT24 Expansion Backplane Card Slot Connectors			
NP ENG:						
MATERIAL:						
MFG:						
MFG ENG:			SIZE: D	SCALE: NONE	DWG. NO. SCH0006914	REV. A00
ISSUED:			DWG FILE:		SHEET 1 OF 3	

©2004 MACKIE DESIGNS INC. ALL RIGHTS RESERVED THE INFORMATION CONTAINED HEREIN IS PROPRIETARY AND CONFIDENTIAL PROPERTY OF MACKIE DESIGNS INC.

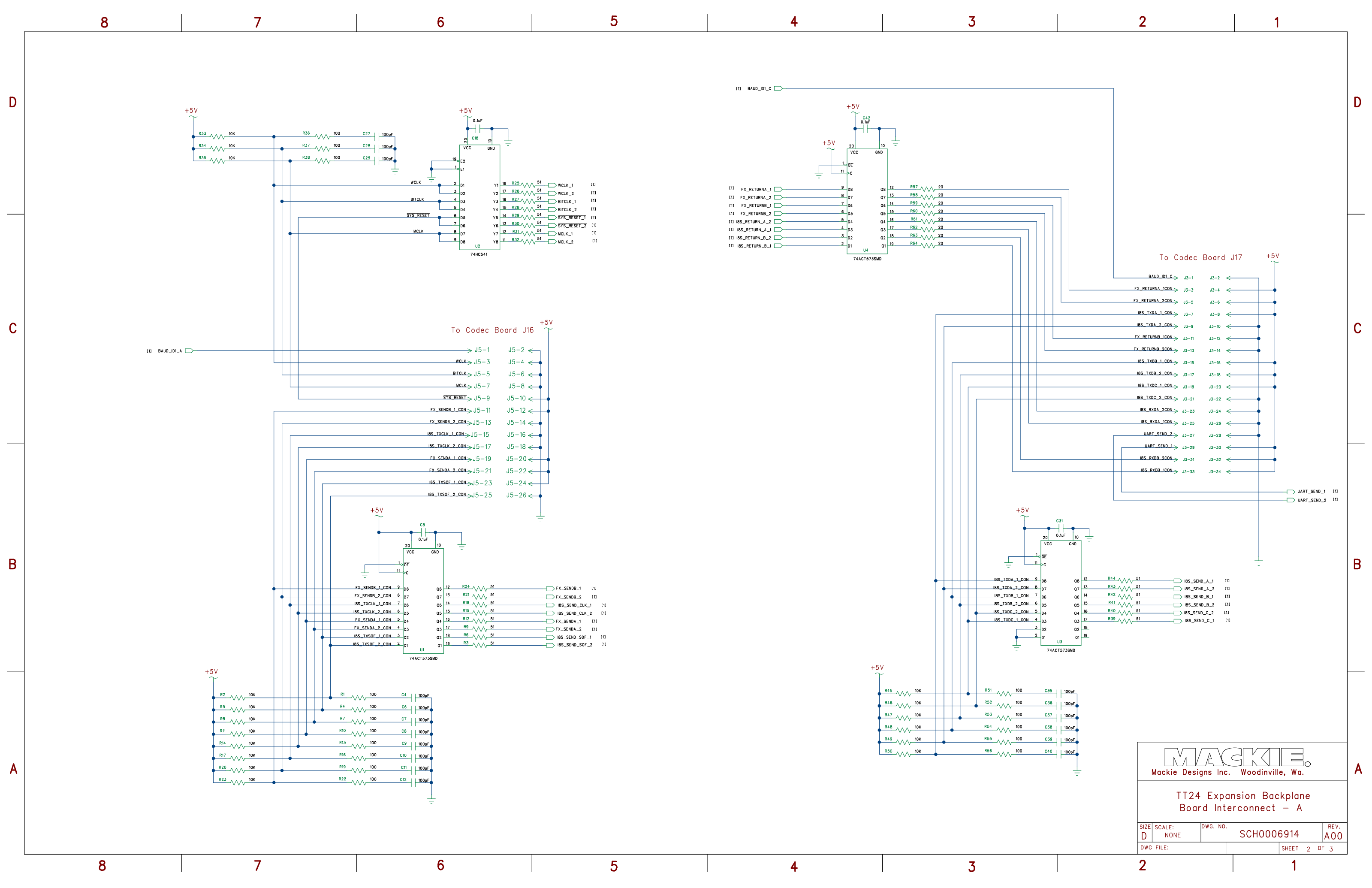

MACKIE
Mackie Designs Inc. Woodinville, Wa.

**TT24 Expansion Backplane
Board Interconnect - A**

SIZE D	SCALE: NONE	DWG. NO. SCH0006914	REV. A00
DWG FILE:		SHEET 2 OF 3	

8

7

6

5

4

3

2

1

D

D

C

C

B

B

A

A

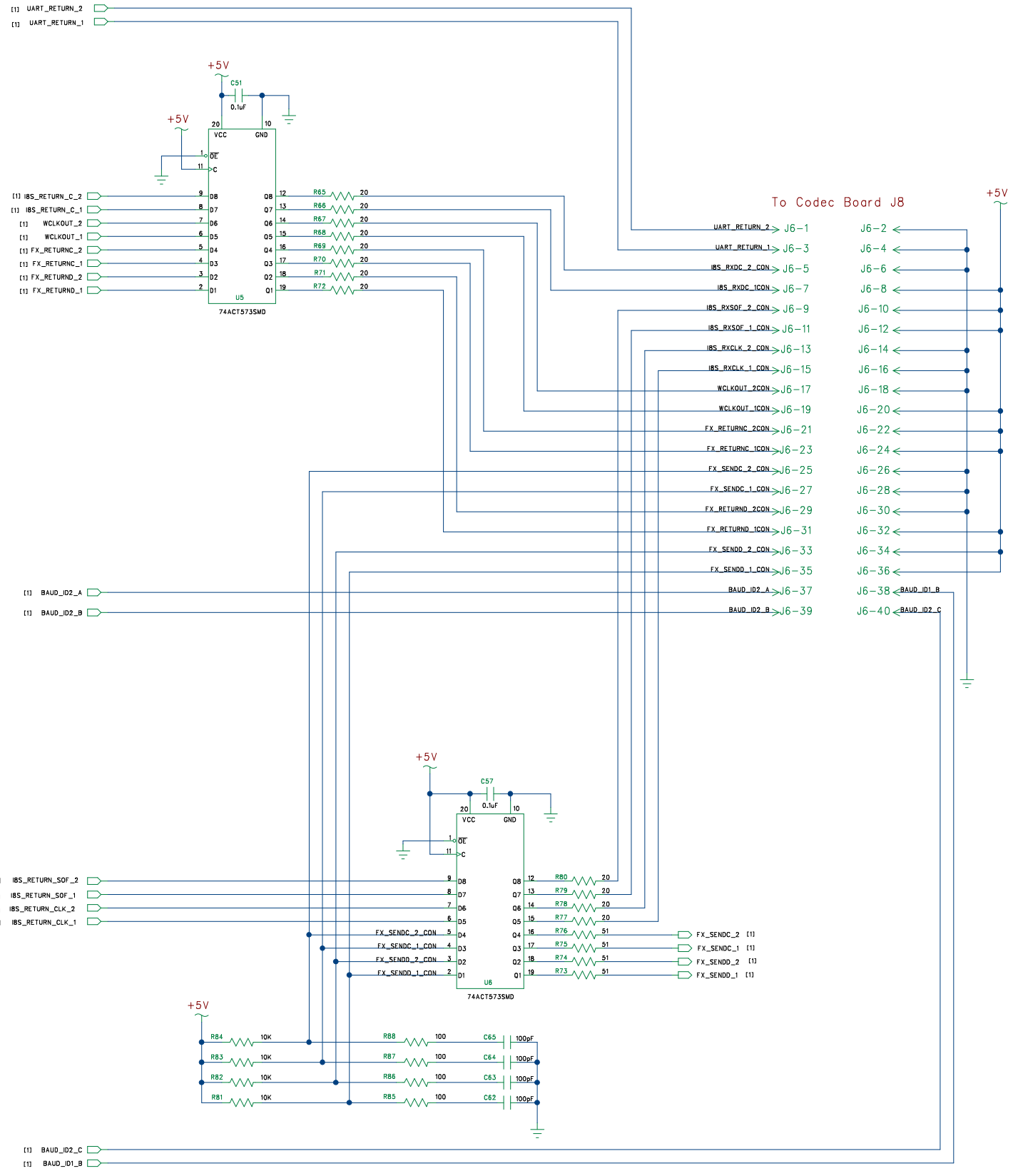

MACKIE
 Mackie Designs Inc. Woodinville, Wa.

TT24 Expansion Backplane
 Board Interconnect - B

SIZE D	SCALE: NONE	DWG. NO. SCH0006914	REV. A00
DWG FILE:		SHEET 3 OF 3	

8

7

6

5

4

3

2

1